



128

szereelési rajz

info@mobelstar.hu

www.mobelstar.hu

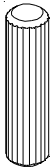
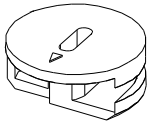
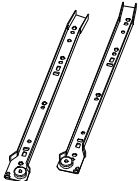
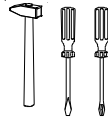

 24x	 9x	 6x balos 6x jobbos		 2 + 4 fiókos komód  Kód.: <h1>128</h1>
 24x				Súly: 37 kg

4/1

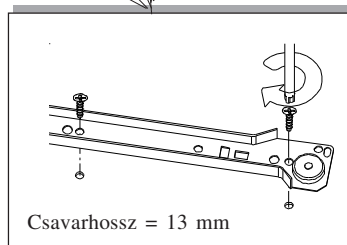
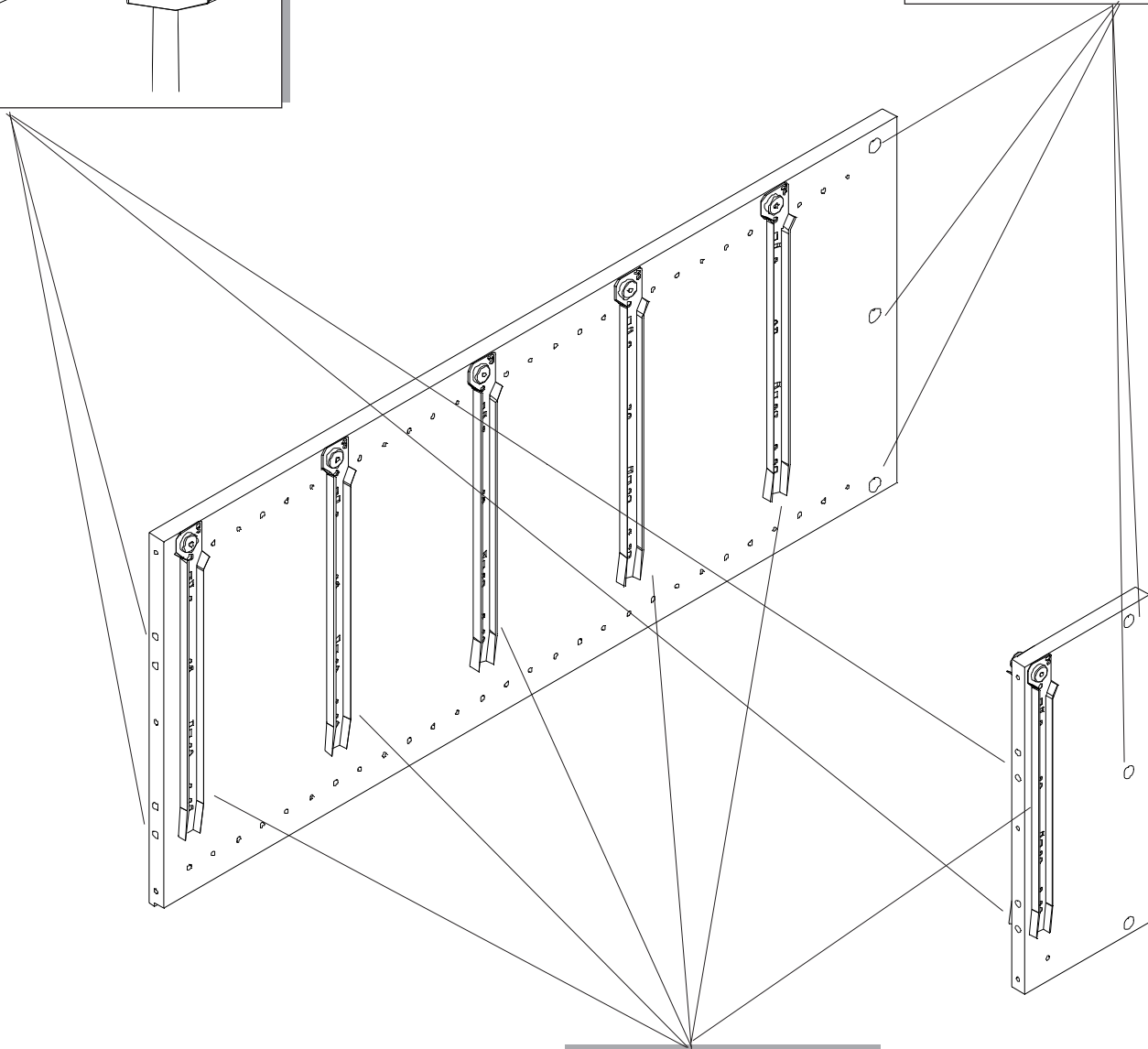
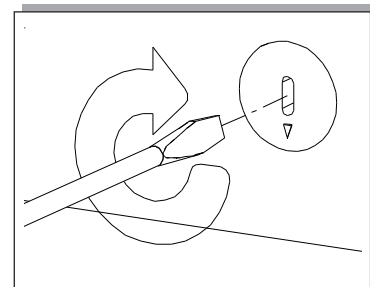
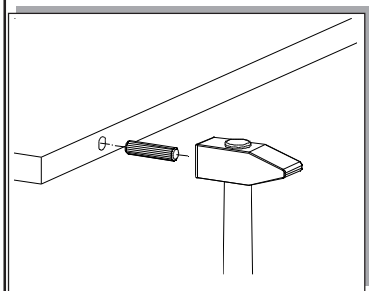

A 128-as szekrénynél a fióksínekkel kezdje a szerelést, a függőleges oszton, a bal ill. a jobb oldalon oldalon egyaránt!

9x

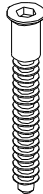
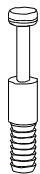

8x



13x



2 + 4 fiókos komód



Kód.:

128

Súly: 37 kg

4/2

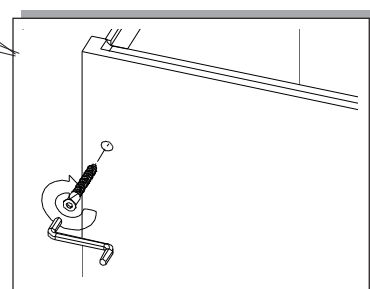
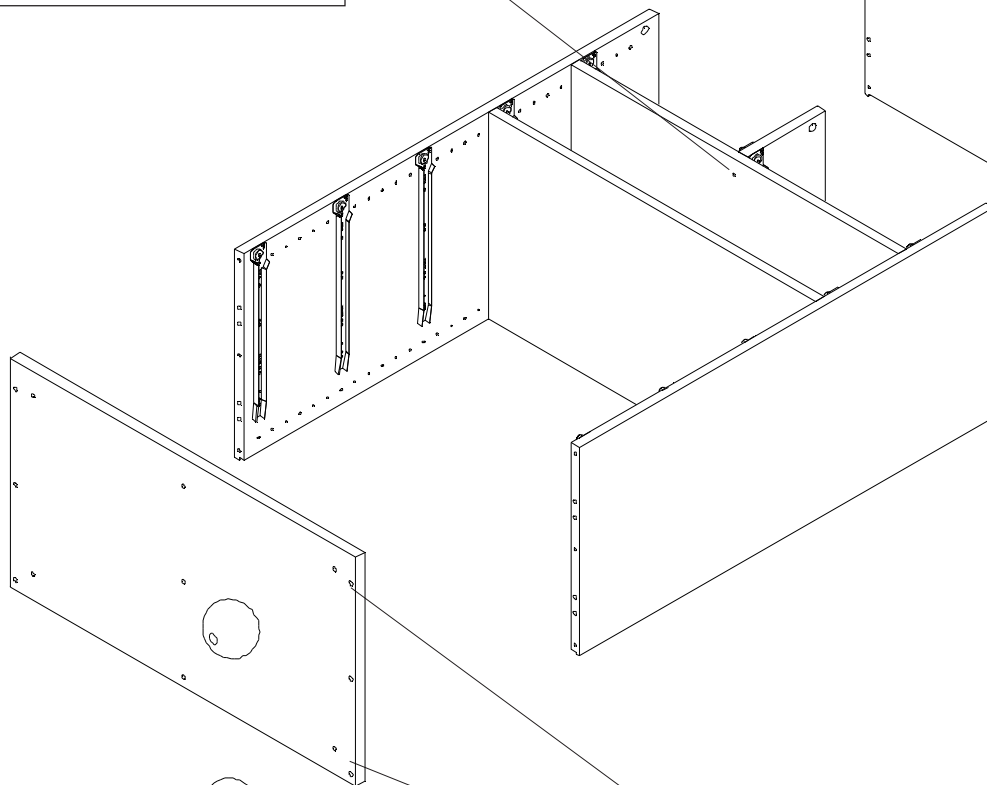
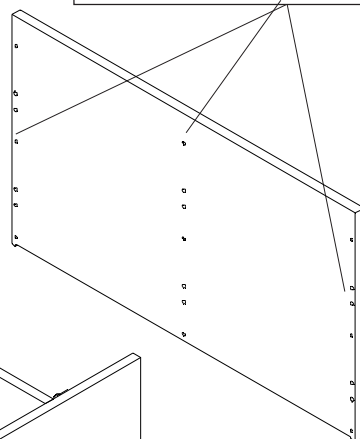
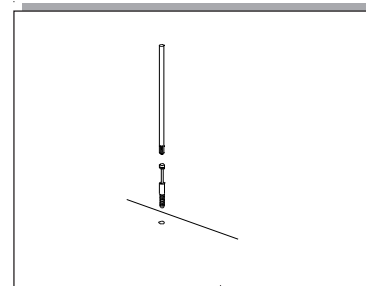
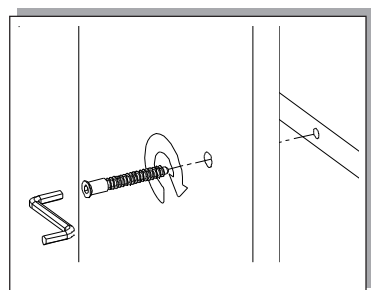

2 + 4 fiókos komód

Kód:

128

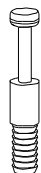

2x

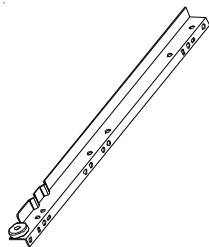

6x
(balos)

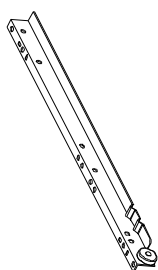

6x
(jobbos)



36x

Csavarhossz = 13 mm



4x

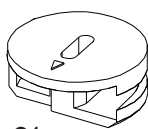

2x

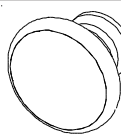

6x

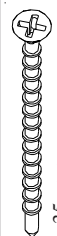

2x

Csavarhossz = 35 mm

4/3

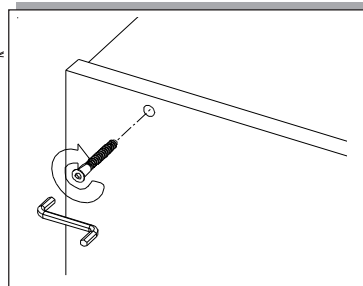
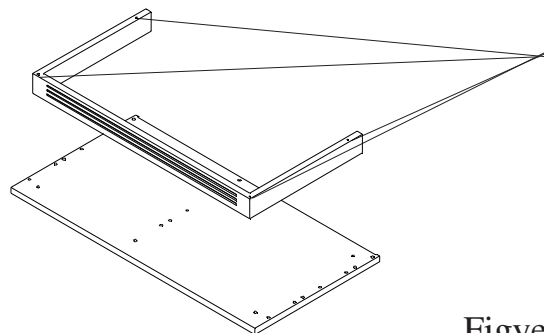

Figyelem! Kétféle lábazat közül választhat!

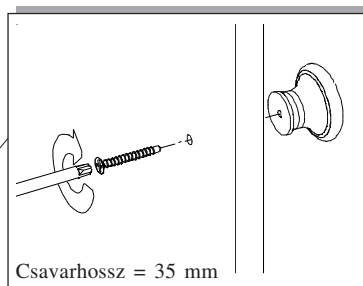
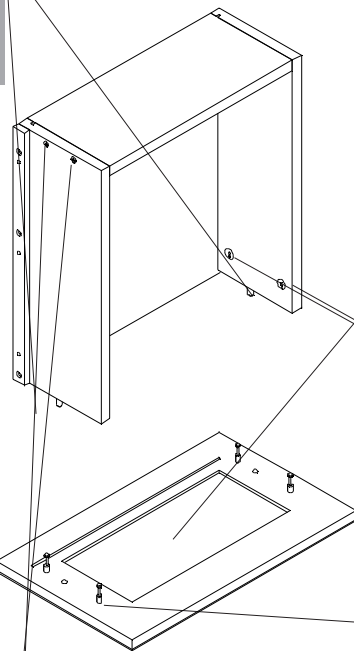
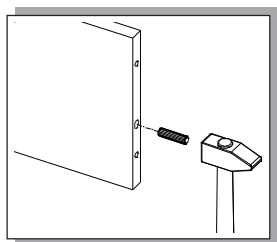

Csavarhossz = 35 mm

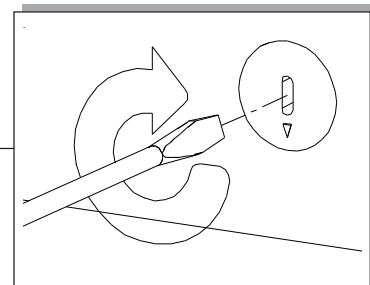
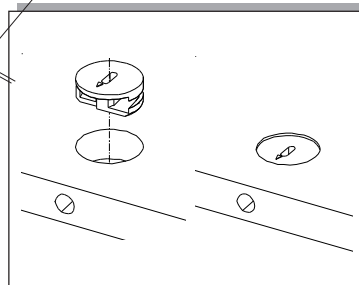

Figyelem!
Fióknál a
metrikus
csavart
használja!

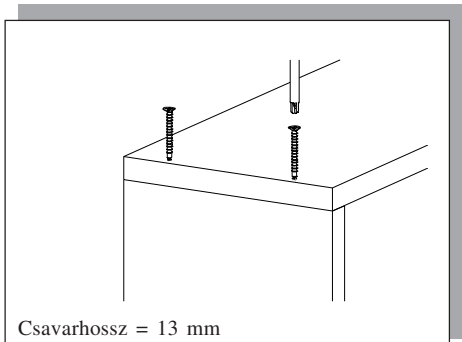

Csavarhossz = 13 mm

Figyelem! A nagy fiókoknál
nem kell paknikat használnia!

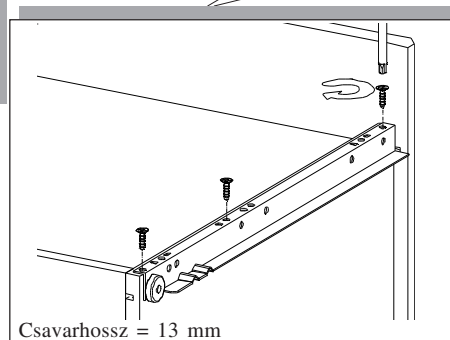

Csavarhossz = 13 mm

Figyelem! Ha a fiókokat a
szekrény jobb oldalán helyezi el,
akkor a fiók bal oldalára kell
felcsavarozni a paknikat, ha bal
oldalt szeretné elhelyezni akkor
a fiók jobb oldalára csavazza a
paknikat!



40x



2 + 4 fiókos komód



Kód: 128

Súly: 37 kg

4/4

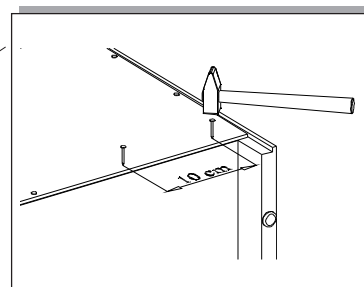

A hátfal felszegelése a legutolsó művelet!